

8 7 6 5 4 3 2 1

F

F

E

E

D

D

C

C

B

B

A

A

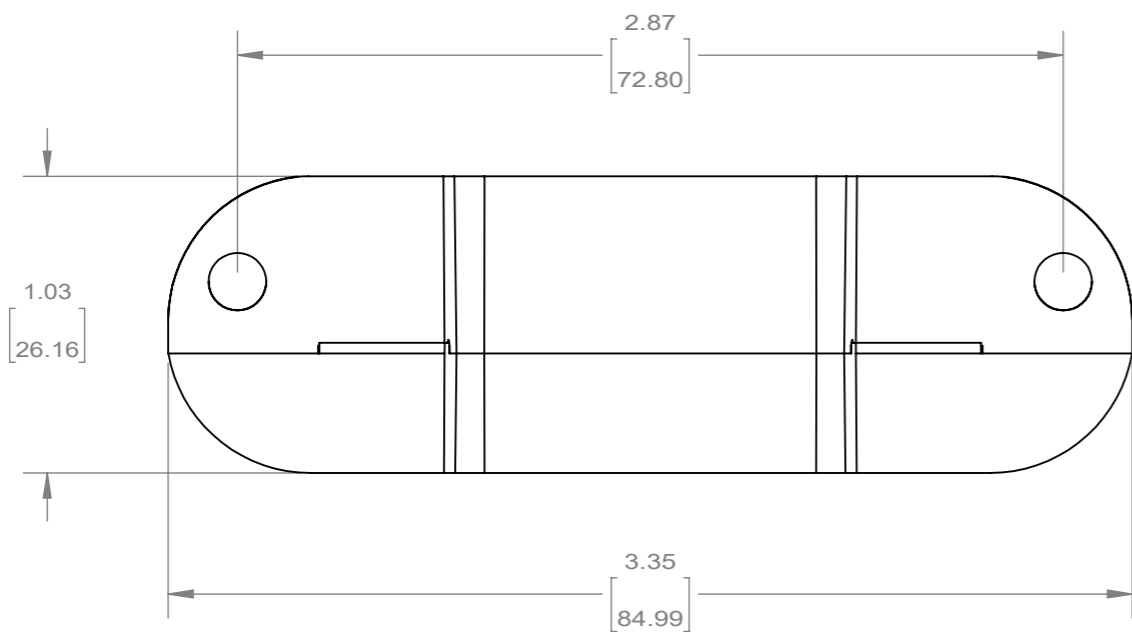
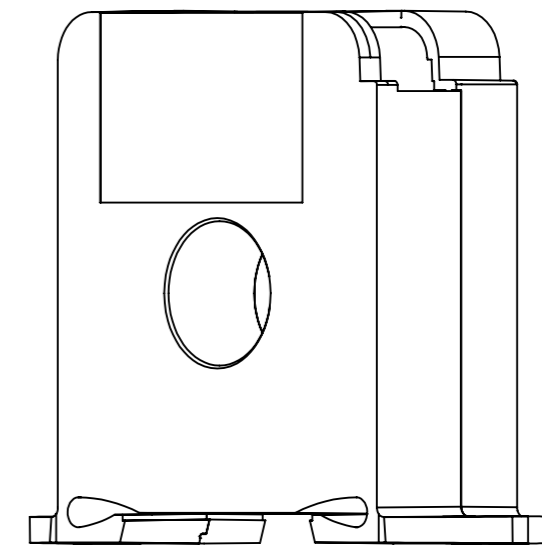
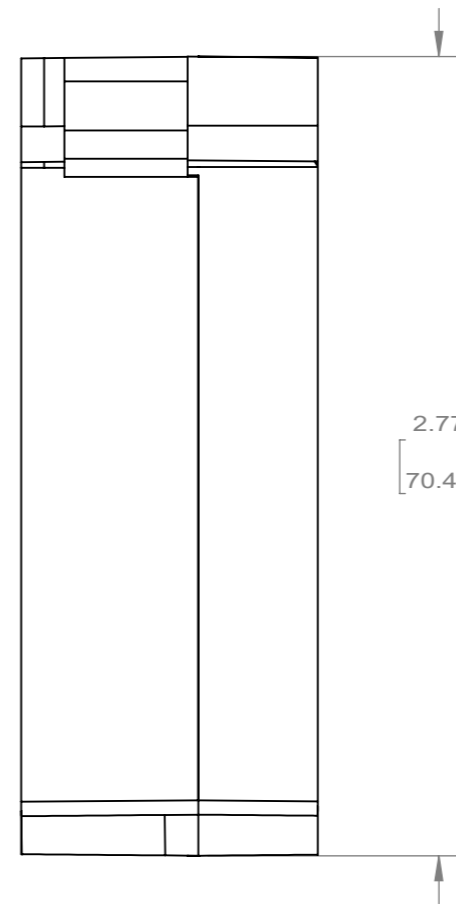
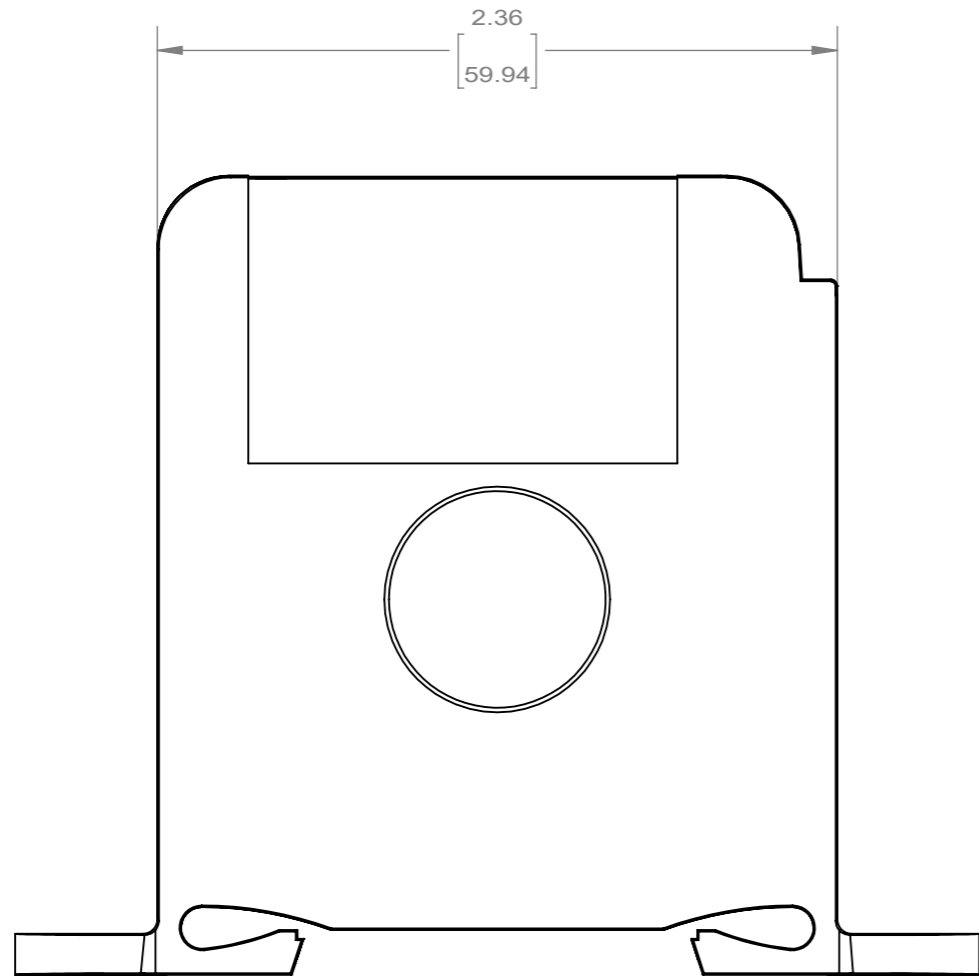

DO NOT SCALE DRAWING		NOT FOR MANUFACTURING USE.	
ACI PRODUCT DIMENSIONAL DRAWING:			
M0000515			
ITEM NUMBER: A/CTA2-50 ANALOG OUTPUT			
DIMENSIONS ARE FOR REFERENCE ONLY. ALL DIMENSIONS ARE IN INCHES [MILLIMETERS] UNLESS OTHERWISE STATED.	DRAWN BY:	PCA	A3
	DATE:	07/11/2017	
SCALE:1.5:1		SHEET 1 OF 1	

8 7 6 5 4 3 2 1